

**Product Code:** K SNKSL EF C  
**Revision:** D2

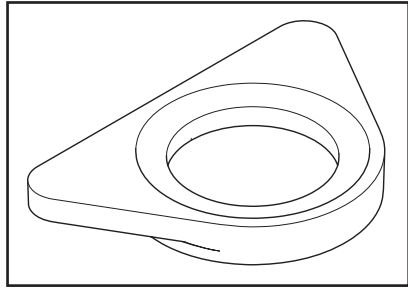

1

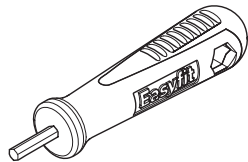

2

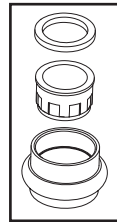

3

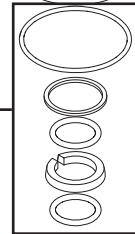

4

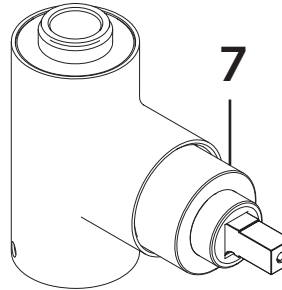

7



5



8



9

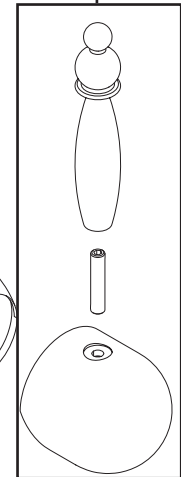

10

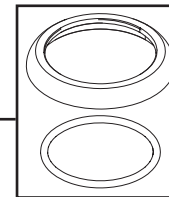

6

1	Reinforcing Plate
2	EasyFit Tool
3	Anti-Splash Assembly
4	Spout Seals Kit
5	M5 x 8mm Grub Screw
6	Plinth & O-Ring
7	40mm Cartridge
8	Cartridge Retaining Nut
9	Shroud
10	Handle Assembly
11	EasyFit Pack
12	Isolation Valves (Pair)
13	Molykote Grease
14	1/2" BSP Flexible Tails (Pair)

**Product Code:** K SNKSL EF C  
**Revision:** D2

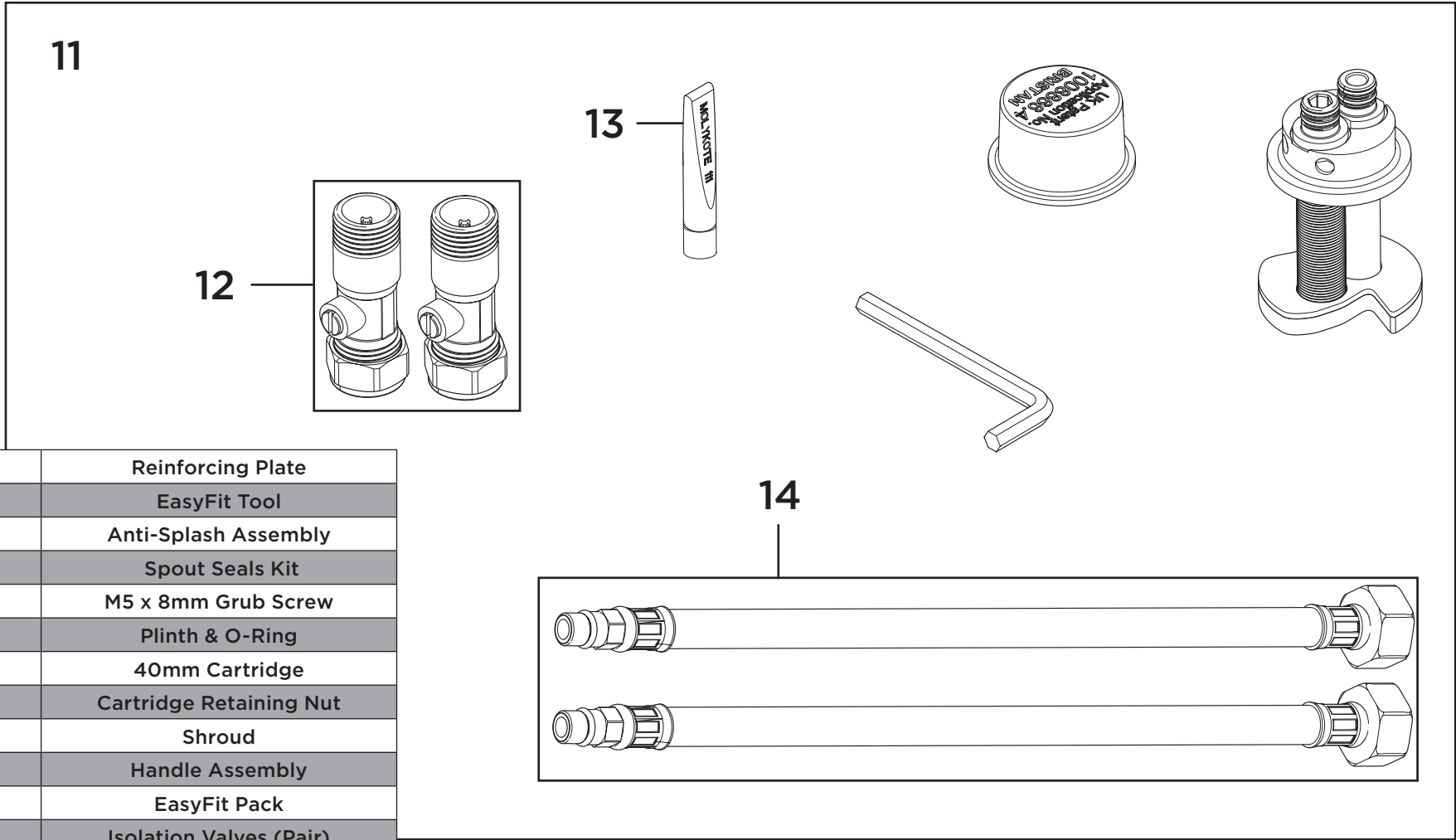

1	Reinforcing Plate
2	EasyFit Tool
3	Anti-Splash Assembly
4	Spout Seals Kit
5	M5 x 8mm Grub Screw
6	Plinth & O-Ring
7	40mm Cartridge
8	Cartridge Retaining Nut
9	Shroud
10	Handle Assembly
11	EasyFit Pack
12	Isolation Valves (Pair)
13	Molykote Grease
14	1/2" BSP Flexible Tails (Pair)