

N2 CSHCVO C

1901 Shower Range 1901 Concealed Concentric Chrome Shower Valve Only



Features:

- 15mm inlet connections
- 168mm inlet centres
- Thermostatic cartridge with preset temperature stop at 42°C
- Supplied with 2 x 8L/min flow regulators
- This shower valve has been designed to fit in any UK wall cavity and therefore only needs a 35mm deep cavity space

Product Certifications:



WRAS Certificate No: 2206907
WRAS Expiry Date: 30/06/2027



For more products, visit our website:
<http://www.bristan.com>



Specification

Finish/Colour:	Chrome
Main Construction Material:	Brass
No of Controls:	2
Shower Type:	Concealed
Shower Head Type:	None
Valve/Cartridge Type:	Thermostatic
Maximum Hot Water Supply Temperature °C:	65
Plumbing System Suitability:	Suitable for plumbing systems - Ideally balanced
Minimum Dynamic Pressure (bar):	0.2
Maximum Dynamic Pressure (bar):	5
Maximum Static Pressure (bar):	10
Connection Inlet:	G1/2"
Connection Outlet:	G1/2"
Isolation Valve Included:	No
Check Valve Included:	No

Dimensions (measurements in mm)

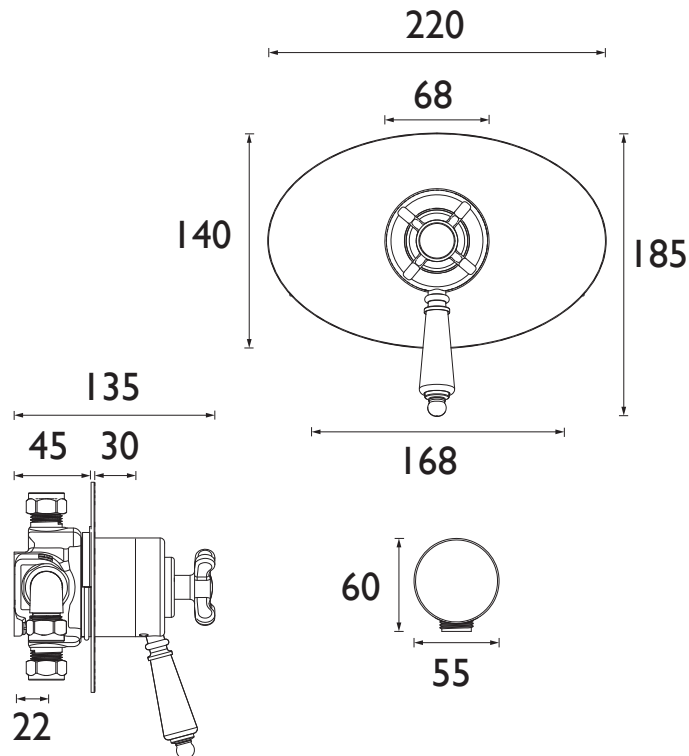

Flow Rates (l/min)

System Pressure (bar)	0.2	0.5	1	2	3	5
Valve Only/Largest FR (mixed)	9.0	5.4	7.8	11.3	11.1	11.4

TECHNICAL DATA SHEET



BRISTAN

D6