

QD 1/2 E4 C

QUADRATO Tap Range Quadrato Basin Taps Eco4 Chrome



Features:

- Supplied with metal handles
- Product supplied with 2 x 2 litre per minute flow regulators which can be inserted into the threaded tail to reduce water consumption and increase water efficiency (Flow Regulator accurate +/- 10%)
- Chrome plated to BS EN 248

Product Certifications:



For more products, visit our website:
<http://www.bristan.com>



Specification

Product Type:	Bathroom Taps
Main Construction Material:	Brass
Mount Type:	Deck
Handle Type:	Lever
Connection Inlet:	1/2" BSP
Connection Outlet:	M24 Flow Straightener
Number of Tap Holes:	2
Valve/Cartridge Type:	1/2" Ceramic Disc Valve
Plumbing System Requirements:	Suitable for all plumbing systems
Minimum Dynamic Pressure (bar):	0.2 bar
Maximum Dynamic Pressure (bar):	5.0 bar
Maximum Hot Water Temperature °C:	65°C
Maximum Static Pressure (bar):	10 bar
Isolation Included:	No

Dimensions (measurements in mm)

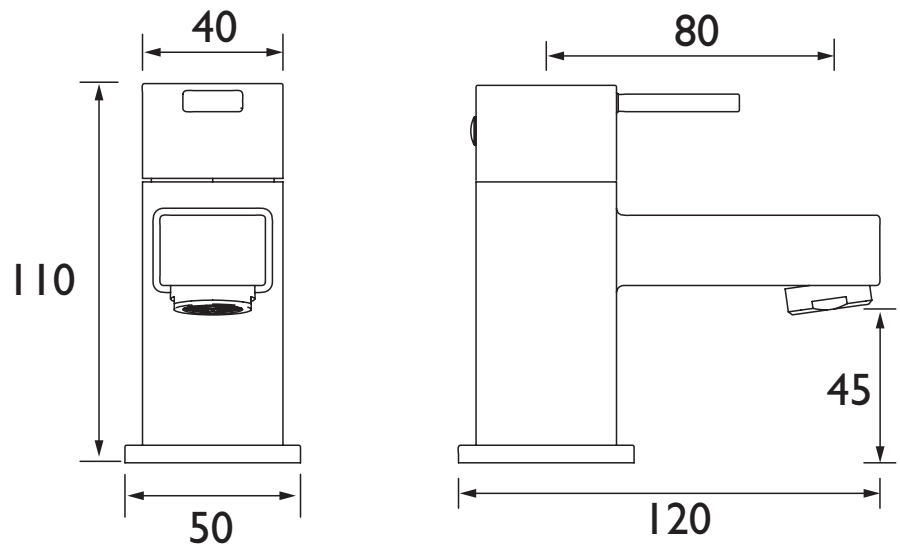

Flow Rates (l/min)

System Pressure (bar)	0.2	0.5	1	2	3	5
QD 1/2 E4 C (Cold)	2	2	2	2	2	2
QD 1/2 E4 C (Hot)	2	2	2	2	2	2

TECHNICAL DATA SHEET



BRISTAN

D4